

Installation – TCS4C_ZX10_2010_AB (revision_02, 07.02.2013)

Author – Mick Boasman



**Nemesis-TCS 'Traction Control System
Installation manual Kawasaki ZX10 2008>2010 with race seat and
performance exhaust without motor valve**

Kit part No.	TCS-4C ZX10_2010.AB
This application is designed for use with the Kawasaki ZX10 2008-2010 model fitted with race seat fairing and the exhaust valve motor removed	

Speed pick up components	Part No	Checked	Qty
Front wheel speed sensor mounting bracket	CSD1375		1
Spacer - OD 12.8 - ID 8.2 - L 7.5	CSD1430		2
M8 x 50 Cap head screw zinc	CSF1054		2
Speed sensor	23813030401		1
M6 x 16 Zinc Hex head cap screw - Speed sensor	CSP1019		1

Traction module components	Part No	Checked	Qty
Traction Control Module - 4c	CSP1048		1
Coil simulator module	CSP1050		1
Kawasaki ZX10 2010 TCS mount	CSD1428		1
TCS - 4C Standard back panel	CSD1337		1
Bobbin - dia 10 x 17 M4 female	CSP1046		4
M4 x 8 button head allen screw s/s	CSF1045		8
M4 Spring washer s/s	CSF1050		8
Double sided glue pad - apply to sides of bracket CSD1428	CSP1020		2

Wiring	Part No	Checked	Qty
Main Wiring Kawasaki ZX10 2010	CSW1429		1
Front Wiring	CSW1371		1
Throttle / speed signal - quick link (red)	CSP1015		2

Display module components	Part No	Checked	Qty
Display module	TC-Pod		1
Spacer - 11mm Dia x 6.5	CS1258		1
M6 x 35 s/s cap head screw - black	CSP1016		1
Push button assembly - blue/green TC-Pod	CS972		1
TC-Pod mount bkt - tripple clamp	CSD1399		1
spacer D12.8, ID8.2, L9.5	CSD1384		1
M8 x 40 Cap head screw zinc	CSF1065		1
M3 x 8 Hex button head	CSP1018		2

Miscellaneous components	Part No	Checked	Qty
Cable ties - 200mm x 4mm	CSP1021		10
Printed TCS system manual			1
Printed Kawasaki ZX10_2010.AB manual			1
Nemesis-TCS stickers	CSP1022		6

Installation – TCS4C_ZX10_2010_AB (revision_02, 07.02.2013)

Author – Mick Boasman

IMPORTANT – To be read by ALL installers and owners

Notes –

- This kit is designed for use on bikes fitted with a 'race type' seat fairing and standard rear speed pick fitted into the gearbox with 23/30 ratio in 6th gear. The bike must also have the exhaust valve motor removed to enable sufficient space to fit the TCS module.
- Power for the TCS system is via the Kill switch. After Kill-ON (bike in Run position) the TCS system needs 3 seconds to 'boot up', the engine will not start during this period.
- This kit uses the rear speed sensor on the gearbox output shaft (front sprocket). For customers who are not using our default sprocket ratio of **17/41** you will need the additional WinTC programming tool to change this.

Terms of use

The presence of the Nemesis-TCS does not take away the responsibility of the rider to operate the bike correctly within their own abilities, the track conditions and the laws of physics.

The system is designed to achieve greater on-track performance by the use of power modulation during wheel slip events, but in no way should it be considered possible for the system to recover from every conceivable loss of grip. The onus for safety always rests with the rider to stay within his or her own abilities, and to ensure that the 'on-bike' equipment is programmed, setup correctly, and an appropriate TC level selected for the skill of the rider, the bike and the track conditions.

This equipment is intended for racing or track day performance use only and where exhaust emission controls are not applicable.

By installing and using the Nemesis-TCS you automatically indemnify Competition Systems Ltd, our suppliers and our authorised dealers from all first party or third party loss or damages. Normal components warranty is not affected

Preparation. Remove these parts from the bike.

- All fairing panels
- Fuel tank
- Air box and intake
- Seat fairing

TC-Display pod Fitting:

- Mount the display pod to the bracket using the M3x8mm screws.
- This bracket for mounting the display is supplied straight. For optimum installation on the Kawasaki you should bend this until the display is aligned correctly, as seen here.
- Fit the angled bracket to the upper triple clamp bolt using the 9.5mm spacer and longer bolt we provide.
- The wiring can be secured to the ignition switch to damp out some vibration.
- Take care to ensure full steering movement without collision with the display pod
- Mount the CS972 switch assembly to the clutch lever assembly cylinder clamp using the M6x35 bolt and spacer provided. Connect the CS972 switch assembly to the TC-Pod via the 4-way connector of the TC-Pod wiring
- Do not secure any wires in place at this stage, as there will be further wires added in this region.
- If installing a pit limiter switch, mount it on the right brake lever assembly.

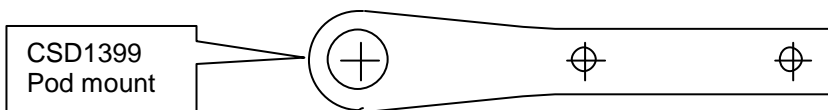

Installation – TCS4C_ZX10_2010_AB (revision_02, 07.02.2013)

Author – Mick Boasman

Front Wheel Speed:

Your TCS kit comes with a dedicated bracket, sensor and spacers to pick up from the standard disk bolts. This system is designed to use the standard low height ferrous bolts; titanium or stainless bolts may not be used.

- Remove the two M8 spindle clamp bolts from the left fork leg. Use the two new longer M8x50mm bolts, spacers and bracket but do not at this stage tighten these bolts.
- Remove the rubber O ring from the sensor body and fit into the rebate of the sensor bracket.
- Push the sensor into the bracket. Lock in place using the M6x16 dome cap screw
- **Check the gap between the sensor face and the surface of one of the new disc bolts, set to 1mm to 2.5mm** and now tighten the two M8 bolts to the manufacturers recommended torque.
- The sensor maximum range is approx 4mm for smaller targets and 6mm for larger targets, therefore no other ferrous objects should be installed anywhere near this sensor
- **These are safety critical components and could result in wheel locking, brake failure or TCS damage if fasteners come loose.**

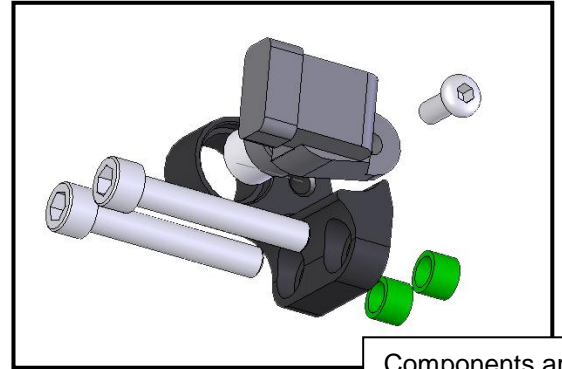

Components are shown in different colours for clarity only



IMPORTANT – Care should be taken when using paddock stands not to damage the wiring or sensor mounting

Installation – TCS4C_ZX10_2010_AB (revision_02, 07.02.2013)

Author – Mick Boasman

Wiring

The wiring provided in this kit comes in 2 parts to simplify the installation and enable crash damaged parts to be replaced without a major strip down. It is recommended that the front wiring loom be installed first.

Wiring – Front section

The front section wiring (part No.CSW1371) has connections for all of these elements

- 2C - Front speed sensor
- 2F - TC-Pod display
- 2G - Pit lane speed limiter switch
- 2E - PC communication point (4 way AMP)
- 2A - Chassis link
- 2B - Throttle signal (single wire)

This wiring is designed to be routed along the **RIGHT** side of the bike after the removal of the air box. Do not cable tie the wiring in place until all wiring is laid within the bike and connected

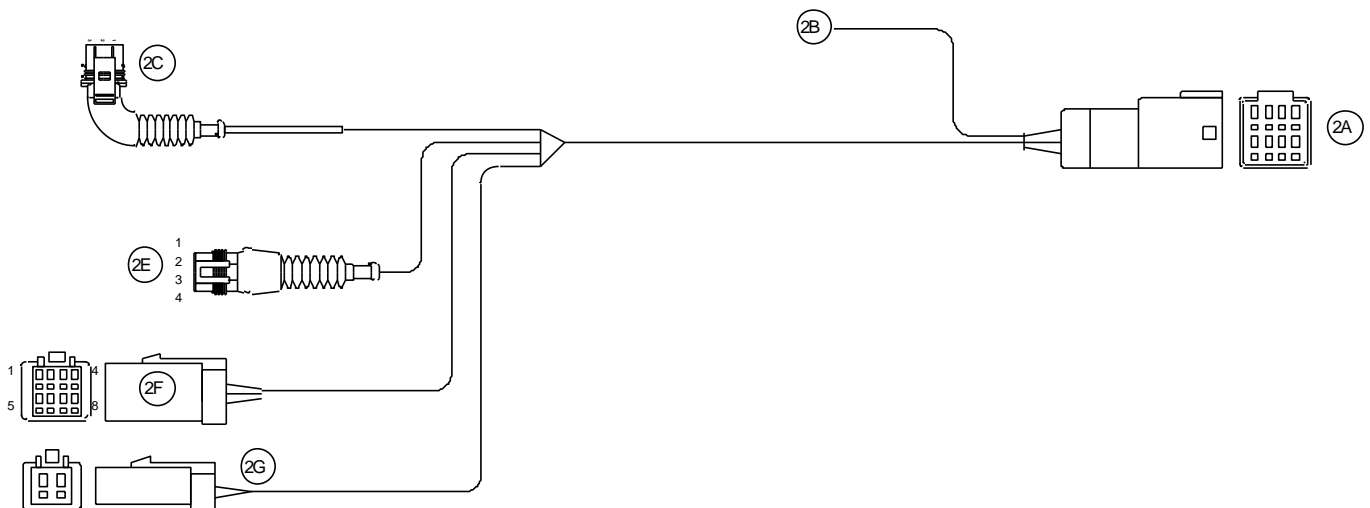

Wiring / Front - Throttle

The throttle input is the wire **2B** of this loom needs to be attached to the **yellow/white** signal_wire of the brown 16 way multi-block connector located at the rear of the throttle body using the red quick link provided in the kit.

Attach the quick link as shown in the steps on the next page.



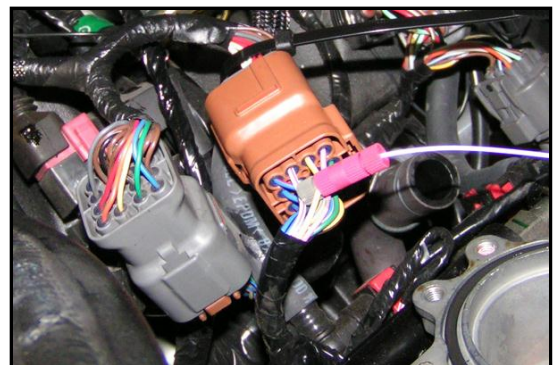

Note that the signal wire is supplied long and may be shortened as necessary



Installation – TCS4C_ZX10_2010_AB (revision_02, 07.02.2013)

Author – Mick Boasman

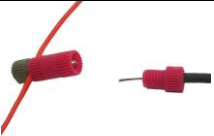
Throttle connection - continued

<p>The quick link is made up of three parts as seen here on the right:</p>	
<p>Using the green section with the slot, push it over the throttle signal wire of the bike loom until the wire rests at the bottom of the slot:</p>	
<p>The large red centre section must be fitted the correct way around or the link will not work. Locate the end with the sharp pointed tip protruding from the end of the outer body and screw this end onto the green section until it rests firmly against the wire. The sharp tip will pierce the outer sleeve but not sever the inner core of the wire:</p>	
<p>Strip back the sleeve of the throttle input wire on the TCS loom so that 8mm of inner metal core is exposed. Push this into the red cap as seen here on the right with inner core showing:</p>	
<p>Screw this cap and wire into the main body ensuring that metal inner core and wire cores are sandwiched and held securely.</p> <p>Shrink sleeving can be put over this quick link if required.</p>	

Wiring / Front – TC-Pod display

Connect the front wiring loom to the TC-Pod display via the 8 way connector **2F**

Wiring / Front – front wheel speed

Route the front speed wiring **2C** across the front of the bike and following the same route as the brake line to the left calliper, connect it to the front speed sensor. The wiring for sensor must be routed taking all of the following into consideration.

- Movement of forks
- Rotation of the steering
- Positioning of paddock stands

Wiring / Front – PC connector

The 4 way PC connector should remain accessible but securely cable tied to the existing harness. Avoid water ingress at this connector

Wiring / Front – Pit limiter switch

The 2 way pit limiter switch connector can be cable tied out of the way if not needed or plugged into the dedicated red switch assembly CSP1041 shown in this picture (not supplied as part of the kit)



Installation – TCS4C_ZX10_2010_AB (revision_02, 07.02.2013)

Author – Mick Boasman

Wiring – Rear section / Ignition coils

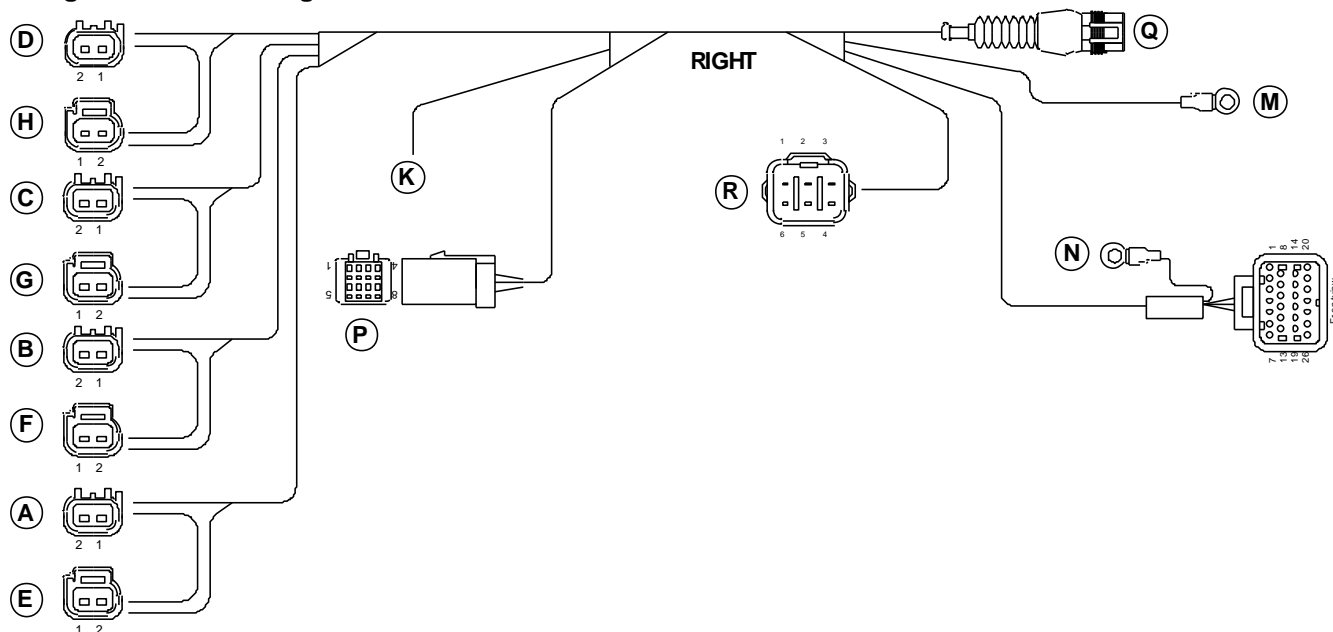

Route this loom section along the **RIGHT** side of the bike following the standard wiring route and starting from the rear compartment where the TCS module will be located.

The following 4 connections are all ignition coil **INPUT** signals from the bike to the TCS unit and must be routed on the

- A - Connect to Coil 1 wiring from bike wiring loom
- B - Connect to Coil 2 wiring from bike wiring loom
- C - Connect to Coil 3 wiring from bike wiring loom
- D - Connect to Coil 4 wiring from bike wiring loom

The following 4 connections are all ignition coil **OUTPUT** signals from the TCS to the drive the ignition coils and must be routed on the

- E - Connect to Coil 1 on the bike
- F - Connect to Coil 2 on the bike
- G - Connect to Coil 3 on the bike
- H - Connect to Coil 4 on the bike

IMPORTANT – It is vitally important that the coil inputs and outputs are connected correctly or the bike may not start on all cylinders, or may even damage the engine.

Wiring – Rear speed

Locate the grey 10 way multi-block connector at the rear left of the throttle body. Now locate the blue wire with yellow stripe as seen in this picture and link it to wire **K** of the TCS loom using the remaining red quick link. In this way the rear speed signal is shared between the TCS module and the dashboard/ECU.

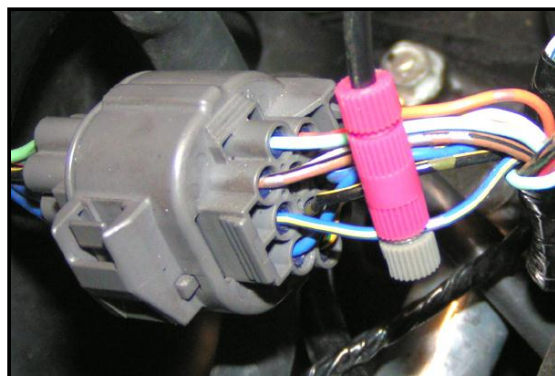

Wiring – Front link

Connector **P** should be routed along the **RIGHT** side of the bike all the way to connect up with **2A** from the front loom.

Installation – TCS4C_ZX10_2010_AB (revision_02, 07.02.2013)

Author – Mick Boasman

Wiring – Battery connections

This vital connection **M** must be connected directly to the battery negative connector, not to the engine block or any other ground source.

IMPORTANT – Failure to fit the ground securely can lead to misfire / engine not starting / TCS module damage. This is the main power ground for the coil system.

Wiring – Quick shifter input

Connector **Q** is available for use with most type of OFF/ON switch type quick shifter.

Pin 1 – Vbat power

Pin 2 – Ground

Pin 3 - Signal

For more information on quick shifter connections please refer to the 'System manual'

Wiring – Coil correction device

The module shown in this picture must be plugged in at all times via the 6 way connector **R**. Without this the bike will stop within 2 seconds and identify an ignition coil error.

The module requires no special mounting or orientation and may be tucked into any suitable space on the rear of the bike.

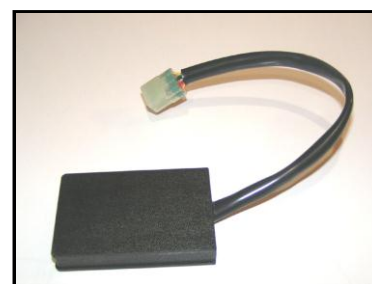

Wiring – TCS module and ground

Connect the main wiring loom to the TCS module. It is vitally important that the small ground wire with the 4mm eye (**N**) be connected securely to the M4 stud using the M4 Nyloc nut. Without this the module or coils could be damaged as well as TCS not functioning correctly.

The TCS module mounting bracket and TCS module are held together using the 4 rubber mounts, screws, washers and brackets shown here and in the images on the next page.

Note that the mounting location circled here for the exhaust valve motor must be shortened by 5mm to provide clearance for the TCS module.

The mounting plate should be secured to the sub-frame using the double sided adhesive on the panel and cable ties at the locations shown.

IMPORTANT – Failure to fit the module in the orientation shown and mounted on a horizontal axis will significantly affect the functionality of the TCS system, if any adjustment is necessary use M4 plain washers under the rubber mounts.

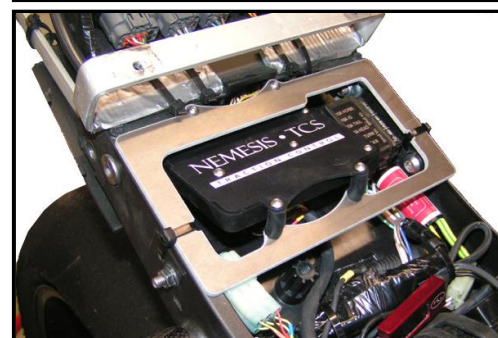

Installation – TCS4C_ZX10_2010_AB (revision_02, 07.02.2013)

Author – Mick Boasman

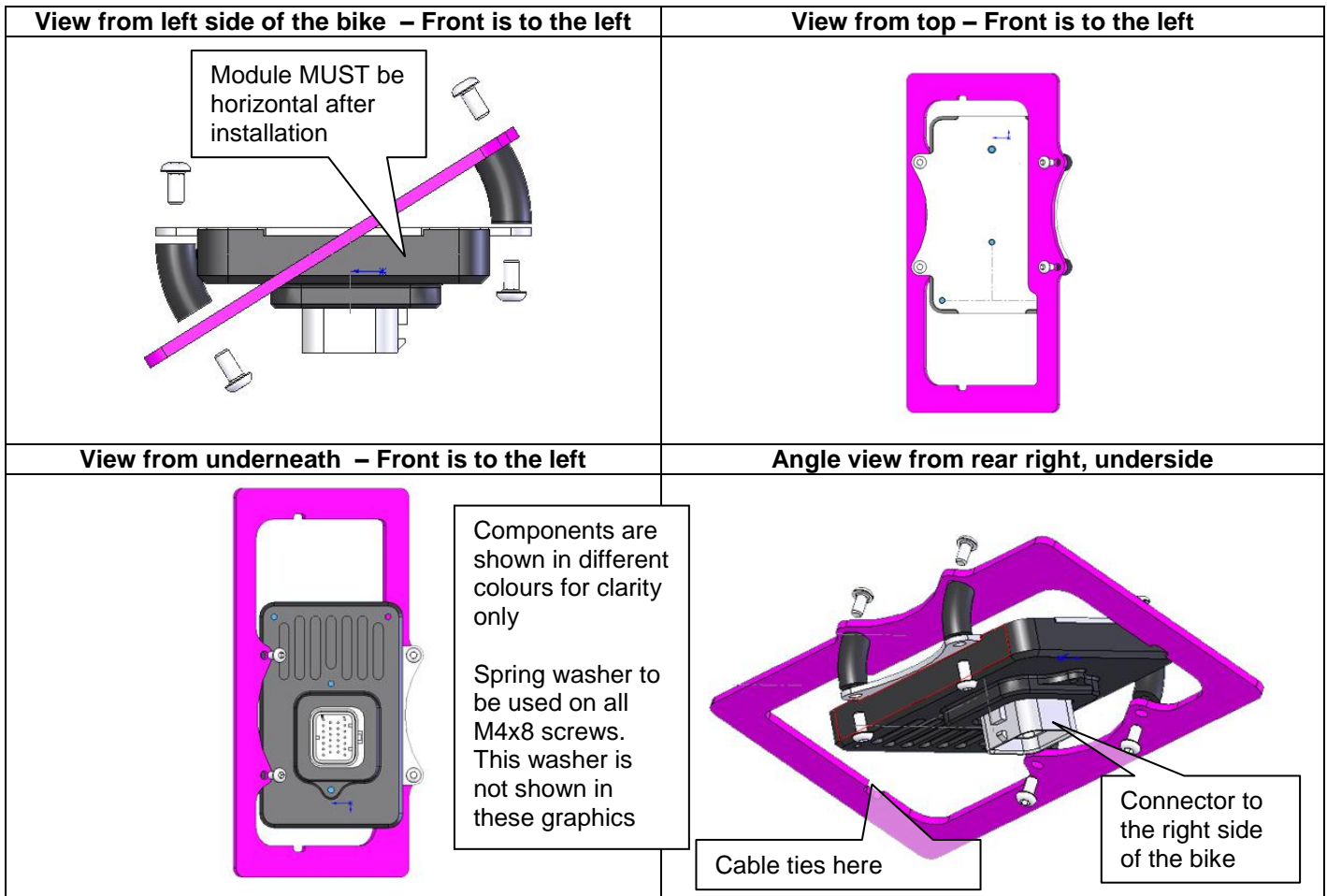

PC Setup

Your TCS module should be loaded with the following bike :

BIKE - KAWA ZX10_10_C.BIKE

TYRE – To suit your installation

CONFIG - TCS_4C_Base_35_02.CONFIG

Standard rear sprockets for maps are: 17/41

Gear box output shaft teeth count: 30

Status **Position** offset value –

Stronger - **0.21 to 0.32** – Refer to **WinTC View Data**

Normal - **0.32 to 0.37** – Refer to **WinTC View Data**

Weaker - **0.37 to 0.47** – Refer to **WinTC View Data**

Note : The WinTC installation guide can be found in the manual - Win-TC 4C manual_v2.05_a.pdf