

**Installation – Yamaha\_R1\_2007\_08.AC (revision\_03, 07.02.2013)**

Author – Mick Boasman

# NEMESIS - TCS

## Nemesis-TCS 'Traction Control System Installation manual Yamaha R1 2007\_2008 with Standard or race seat

UK

Tel – 08707 444 666

Fax – 08707 444 888

Kit part No.	TCS-4C-YAM R1_07_08.AC
This application is designed for use with the Yamaha R1 2007_2008 model bike fitted either with the standard seat or a race seat.	

Speed pick up components	Part No	Checked	Qty
Front left fork leg speed bracket	CSD1410		1
Spacer - D12.8 / B8.2 / L9.5	CSD1384		2
M6 x 22 shoulder screw - 8mm shank	CSF1059		5
M8 x 60 zinc plated cap screw	CSF1055		2
Speed sensor	23813030401		1
M6 x 16 Zinc Hex head cap screw - Speed sensor	CSP1019		1

Traction module components	Part No	Checked	Qty
Traction Control Module - 4c	CSP1048		1
Ignition coil sim module	CSP1050		1
3M velcro - 25mm length	CSP1049		2
TCS - 4C Horizontal back panel	CSD1378		1
TCS Mounting Plate - R1_07_08 front	CSD1402		1
TCS Mounting Plate - R1_07_08 rear	CSD1403		1
Bobbin - Dia 10x17, M4 female	CSP1046		4
M4 x 8 SS button head allen screw	CSF1045		8
Spacer - 11mm Dia x 6.5	CS1258		2
M6 x 40 s/s cap head screw	CSP1025		2
M6 nyloc nut	CSF1063		2
M4 spring washer	CSF1050		8

Wiring	Part No	Checked	Qty
Module Wiring	CSW1385 – v6		1
Front Wiring	CSW1371		1
Throttle signal - quick link (red)	CSP1015		1

Display module components	Part No	Checked	Qty
Display module	TC-Pod		1
Spacer - 11mm Dia x 6.5	CS1258		1
TC-Pod centre bracket	CS1243		1
TC-Pod mounting bracket - triple clamp	CSD1399		1
M3 x 8 Hex button head	CSP1018		2
M6 x 35 s/s cap head screw	CSP1016		1
Push button assembly - blue/green TC-Pod	CS972		1

Miscellaneous components	Part No	Checked	Qty
Cable ties - 200mm x 4mm	CSP1021		10
Printed TCS over view manual			1
Printed R1_07_08. AC manual			1
Nemesis-TCS stickers	CSP1022		6

## Installation – Yamaha\_R1\_2007\_08.AC (revision\_03, 07.02.2013)

Author – Mick Boasman

### **IMPORTANT – To be read by ALL installers and owners**

#### **Notes –**

- This kit is designed for use on bikes fitted with a 'race type' seat fairing and standard 6<sup>th</sup> gear ratios 33/26
- Power for the TCS system is via the Kill switch. After Kill-ON (bike in Run position) the TCS system needs 3 seconds to 'boot up', the engine will not start during this period.
- This kit uses the rear speed sensor on the gearbox. For customers who are not using our default sprocket ratio of 17/45 you will need the additional WinTC programming tool to change this.

#### **Terms of use**

The presence of the Nemesis-TCS does not take away the responsibility of the rider to operate the bike correctly within their own abilities, the track conditions and the laws of physics.

The system is designed to achieve greater on-track performance by the use of power modulation during wheel slip events, but in no way should it be considered possible for the system to recover from every conceivable loss of grip. The onus for safety always rests with the rider to stay within his or her own abilities, and to ensure that the 'on-bike' equipment is programmed, setup correctly, and an appropriate TC level selected for the skill of the rider, the bike and the track conditions.

This equipment is intended for racing or track day performance use only and where exhaust emission controls are not applicable.

By installing and using the Nemesis-TCS you automatically indemnify Competition Systems Ltd, our suppliers and our authorised dealers from all first party or third party loss or damages. Normal components warranty is not affected

#### **Preparation.** Remove these parts from the bike.

- All fairing panels
- Fuel tank
- Air box and intake
- Seat fairing

#### **TC-Display pod Fitting:**

- Mount the display pod to the generic mounting bracket using the M3x8 screws, now secure it to the M6 bolt of the brake reservoir. This bracket can now be twisted to suit your desired mounting angle and position.
- Use the wiring and cable ties to provide addition anti-vibration support of this component.
- As an alternative we also provide another angled bracket which can be used to locate the display on the air intake tube.
- Take care to ensure full steering movement without collision with the display pod
- Mount the CS972 switch assembly to the clutch lever assembly cylinder clamp using the M6x35 bolt and spacer provided. Connect the CS972 switch assembly to the TC-Pod via the 4-way connector of the TC-Pod wiring
- Do not secure any wires in place at this stage, as there will be further wires added in this region.
- If installing a pit limiter switch, mount it on the right brake lever assembly.

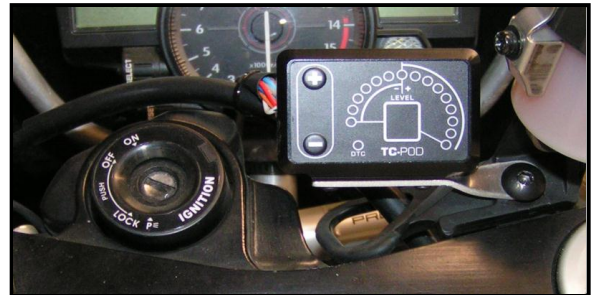

## Installation – Yamaha\_R1\_2007\_08.AC (revision\_03, 07.02.2013)

Author – Mick Boasman

### Front Wheel Speed:

Your TCS kit comes with a dedicated bracket, sensor, spacers and different disc cap-head bolts.

- Remove the 5 bolts that secure the left brake disk in place and replace with the 5 new shoulder screws with higher profile. Fit to the manufacturer recommended torque and thread lock agent. **Under no circumstances should any alternative bolts be used.**
- Remove the two M8 spindle clamp bolts from the left fork and retain for future use. Use the two new longer M8x60mm bolts, spacers and bracket but do not at this stage tighten these bolts.
- Remove the rubber O ring from the sensor body and fit into the rebate of the sensor bracket.
- Apply a small amount of grease to the sensor body and push the sensor into the bracket. Lock in place using one of the M6x16 cap
- **Check the gap between the sensor face and the surface of one of the new disc bolts, set to 1mm to 1.5mm** and now tighten the two M8 bolts to the manufacturers recommended torque.
- The sensor maximum range is approx 4mm for smaller targets and 6mm for larger targets, therefore no other ferrous objects should be installed anywhere near this sensor
- **These are safety critical components and could result in wheel locking, brake failure or TCS damage if fasteners come loose.**

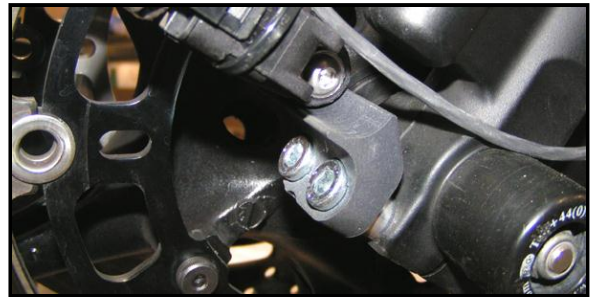
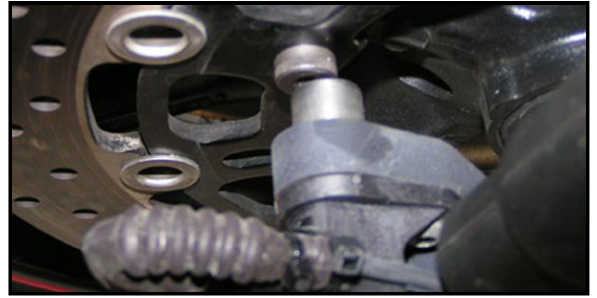

**IMPORTANT** – Care should be taken when using paddock stands not to damage the wiring or sensor mounting

### Wiring

The wiring provided in this kit comes in 2 parts to simplify the installation and enable crash damaged parts to be replaced without a major strip down.

#### Wiring – Front section

The front section wiring (part No.CSW1371) has connections for all of these elements

- 2C - Front speed sensor
- 2F - TC-Pod display
- 2G - Pit lane speed limiter switch
- 2E - PC communication point (4 way AMP)
- 2A - Chassis link
- 2B - Throttle signal (single wire)

This wiring **MUST** be routed along the left side of the bike to avoid electrical interference. Do not at this stage cable tie the wiring in place.

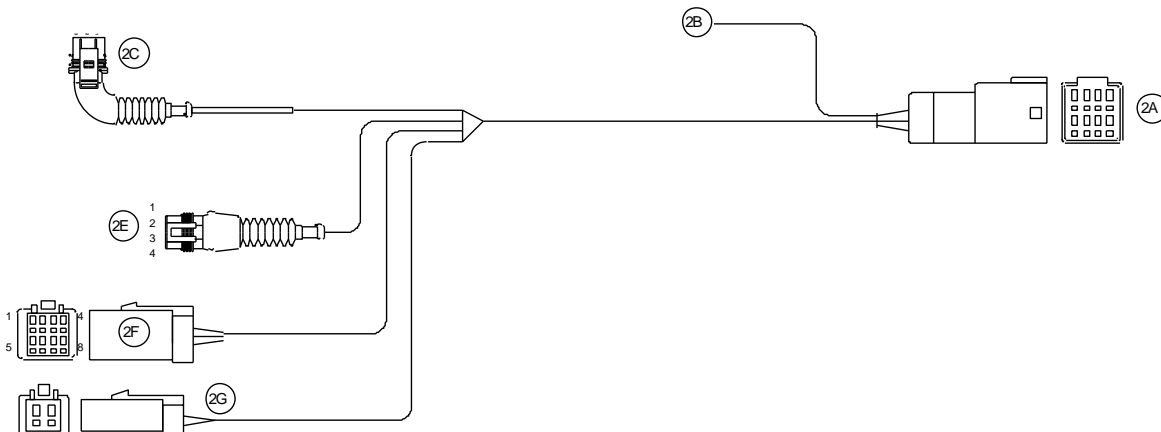

## Installation – Yamaha\_R1\_2007\_08.AC (revision\_03, 07.02.2013)

Author – Mick Boasman





### Wiring / Front - Throttle

The throttle input is the single wire 2B of this loom . This needs to be attached to the signal wire (pin D) of the standard bike throttle **INPUT** position connector using the red quick link provided in the kit, as shown in the steps below and the image to the right.

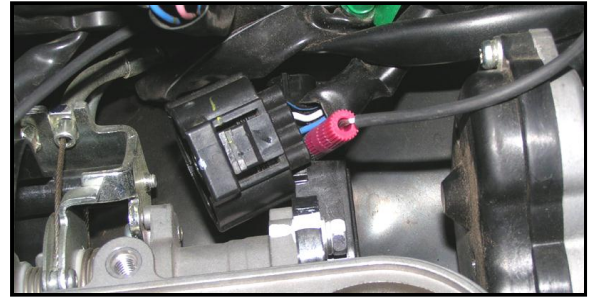
Note that the signal wire is supplied long and may be shortened as necessary and that you are connecting to the throttle 'INPUT' sensor. (not the throttle shaft sensor)

Pin D is the right hand one when looking at the face of the connector

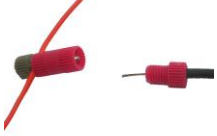

<p>The quick link is made up of three parts as seen here on the right:</p>	
<p>Using the green section with the slot, push it over the orange throttle signal wire of the bike loom until the wire rests at the bottom of the slot:</p>	
<p>The large red centre section must be fitted the correct way around or the link <b>will not work</b>. Locate the end with the sharp pointed tip protruding from the end of the outer body and screw this end onto the green section until it rests firmly against the wire. The sharp tip will pierce the outer sleeve but not sever the inner core of the wire:</p>	
<p>Strip back the sleeve of the throttle input wire on the TCS loom so that 8mm of inner metal core is exposed. Push this into the red cap as seen here on the right with inner core showing:</p>	
<p>Screw this cap and wire into the main body ensuring that metal inner core and wire cores are sandwiched and held securely.</p> <p>Shrink sleeving can be put over this quick link if required.</p>	

### Wiring / Front – TC-Pod display

Connect the front wiring loom to the TC-Pod display via the 8 way connector 2F

### Wiring / Front – front wheel speed

Route the front speed wiring 2C across the front of the bike and following the same route as the brake line to the left calliper, connect it to the front speed sensor. The wiring for sensor must be routed taking all of the following into consideration.

- Movement of forks
- Rotation of the steering
- Positioning of paddock stands

### Wiring / Front – PC connector

The 4 way PC connector should remain accessible but securely cable tied to the existing harness.

### Wiring / Front – Pit limiter switch

The 2 way pit limiter switch connector can be cable tied out of the way if not needed or plugged into the dedicated red switch assembly CSP1041

## Installation – Yamaha\_R1\_2007\_08.AC (revision\_03, 07.02.2013)

Author – Mick Boasman

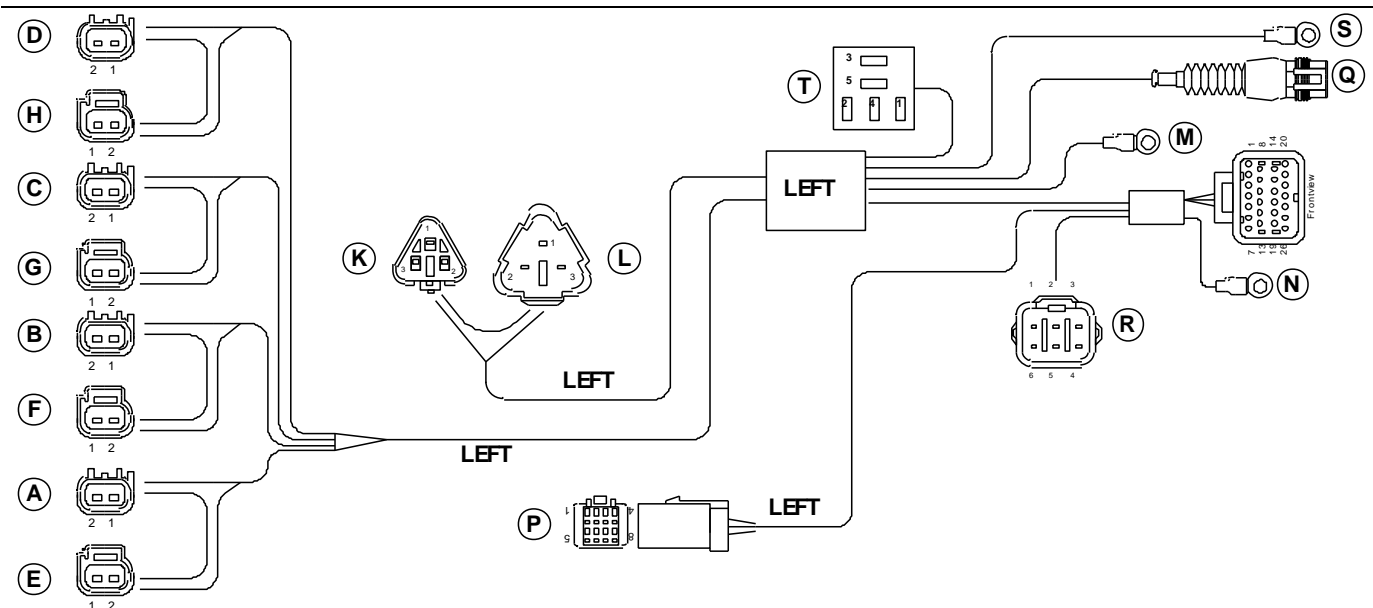

### Wiring – Rear section / Ignition coils

Route this loom section along the LEFT side of the bike following the standard wiring route. The central junction in the middle of this drawing is approximately in-line with the battery.

The following 4 connections are all ignition coil INPUT signals from the bike to the TCS unit and must be routed on the

- A - Connect to Coil 1 wiring from bike wiring loom
- B - Connect to Coil 2 wiring from bike wiring loom
- C - Connect to Coil 3 wiring from bike wiring loom
- D - Connect to Coil 4 wiring from bike wiring loom

The following 4 connections are all ignition coil OUTPUT signals from the TCS to the drive the ignition coils and must be routed on the

- E - Connect to Coil 1 on the bike
- F - Connect to Coil 2 on the bike
- G - Connect to Coil 3 on the bike
- H - Connect to Coil 4 on the bike

**IMPORTANT** – It is vitally important that the coil inputs and outputs are connected correctly or the bike may not start on all cylinders, or may even damage the engine.

### Wiring – Rear speed

Locate the connector of the rear speed sensor and use connections **K** and **L** to bridge this junction. In this way the rear speed signal is shared between the TCS module and the dashboard/ECU.

The speed sensor connector is a 3 way white connector of triangular format located above the gearbox to the left side of the bike. If you are unsure, trace the wire to the sensor which is located roughly behind Cylinder 2, beneath the flexible cover and into the top of the gearbox.

### Wiring – Battery connections

This vital connection **M** must be connected directly to the battery negative connector, not to the engine block or any other ground source. Connector **S** must be connected to battery positive.

**IMPORTANT** – Failure to fit the ground securely can lead to misfire / engine not starting / TCS module damage. This is the main power ground for the coil system.

The TCS system is power fed via these battery connections. The on/off switching of the TCS system is via the relay **T** and controlled by the kill switch. This relay may be fitted in any convenient position.

### Wiring – Front link

Connector **P** should be routed along the LEFT side of the bike all the way to connect up with 2A from the front loom.

### Wiring – Quick shifter input

Connector **Q** is available for use with most type of OFF/ON switch type quick shifter.



## Installation – Yamaha\_R1\_2007\_08.AC (revision\_03, 07.02.2013)

Author – Mick Boasman

Pin 1 – Vbat power

Pin 2 – Ground

Pin 3 - Signal

For more information on quick shifter connections please refer to the 'System manual'

### Wiring – TCS module and ground

Connect the main wiring loom to the TCS module. It is vitally important that the small ground wire with the 4mm eye (**N**) be connected securely to the M4 stud of the module using the M4 Nyloc nut. Without this the module or coils could be damaged as well as TCS not functioning correctly.

The TCS module mounting bracket and TCS module are held together using the 4 rubber mounts, M4x8mm screws and lock washers.



This assembly is then held to the sub frame **horizontally** using the M6x 35 screws and the original M6 screws .

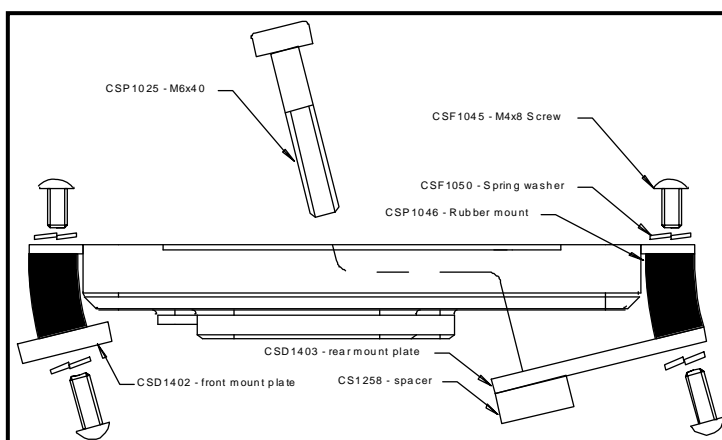

**IMPORTANT** – Failure to fit the module in the orientation shown and mounted on a horizontal axis will significantly affect the functionality of the TCS system.

### Wiring – Coil correction device

The module highlighted in this picture must be plugged in at all times via the 6 way connector R. Without this the bike will stop within 4 seconds and identify an ignition coil error.

The module requires no special mounting or orientation and may be tucked into any suitable space on the rear of the bike.

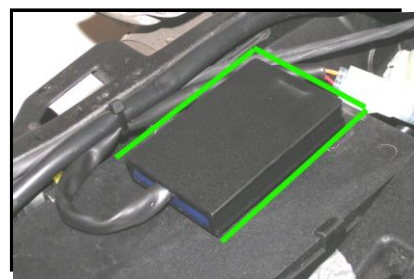

### PC Setup

Your TCS module should be loaded with the following bike :

BIKE - Yamaha R1\_07\_08\_C.BIKE

TYRE – To suit your installation

CONFIG - TCS\_4C\_Base\_35\_02.CONFIG

Default rear sprockets for maps are: 17/45

Status **Position** offset value –

Stronger - **0.21 to 0.32** – Refer to **WinTC View Data**

Normal - **0.32 to 0.37** – Refer to **WinTC View Data**

Weaker - **0.37 to 0.47** – Refer to **WinTC View Data**

Note : The WinTC installation guide can be found in the manual - Win-TC 4C manual\_v2.05\_a.pdf